

## PRODUCT FEATURES

- IGBT chip in trench FS-technology
- Low switching losses
- $V_{CE(sat)}$  with positive temperature coefficient
- Fast switching and short tail current
- Free wheeling diodes with fast and soft reverse recovery

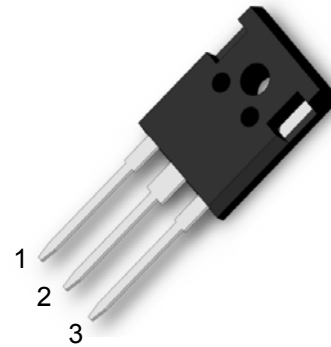

## APPLICATIONS

- High frequency switching application
- Medical applications
- Motion/servo control
- UPS systems

1.Gate  
2.Collector  
3.Emitter

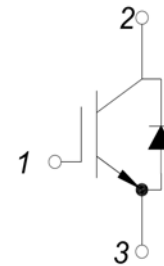

| Type        | $V_{CES}$ | $I_C$ | $V_{CE(sat)}$ $T_J=25^\circ C$ | $T_{Jmax}$ | Marking     | Package |
|-------------|-----------|-------|--------------------------------|------------|-------------|---------|
| MM25G3T120B | 1200V     | 25A   | 1.8V                           | 175°C      | MM25G3T120B | TO-247  |

## ABSOLUTE MAXIMUM RATINGS( $T_C=25^\circ C$ unless otherwise specified)

| Symbol      | Parameter/Test Conditions                          | Values            | Unit |    |
|-------------|----------------------------------------------------|-------------------|------|----|
| $V_{CES}$   | Collector Emitter Voltage                          | $T_J=25^\circ C$  | V    |    |
| $V_{GES}$   | Gate Emitter Voltage                               |                   |      |    |
| $I_C$       | DC Collector Current                               | $T_C=25^\circ C$  | A    |    |
|             |                                                    | $T_C=110^\circ C$ |      |    |
| $I_{Cpuls}$ | Pulsed collector current, tp limited by $T_{Jmax}$ | 80                |      |    |
| $P_{tot}$   | Power Dissipation Per IGBT                         | 326               | W    |    |
| $V_{RRM}$   | Repetitive Reverse Voltage                         | $T_J=25^\circ C$  | V    |    |
| $I_{F(AV)}$ | Average Forward Current                            | $T_C=100^\circ C$ | A    |    |
| $I_{Fpuls}$ | Diode pulsed current, tp limited by $T_{Jmax}$     | 40                |      |    |
| $T_{Jmax}$  | Max. Junction Temperature                          | 175               | °C   |    |
| $T_{Jop}$   | Operating Temperature                              | -40~175           |      |    |
| $T_{stg}$   | Storage Temperature                                | -55~150           |      |    |
| Torque      | to heatsink                                        | Recommended (M3)  | 1.1  | Nm |
| Weight      |                                                    |                   | 8    | g  |

MacMic Science & Technology Co., Ltd.

Add: #18, Hua Shan Zhong Lu, New District, Changzhou City, Jiangsu Province, P. R. of China

Tel.: +86-519-85163708 Fax: +86-519-85162291 Post Code: 213022 Website: www.macmicst.com

# MM25G3T120B

## IGBT

### ELECTRICAL CHARACTERISTICS ( $T_C=25^\circ\text{C}$ unless otherwise specified)

| Symbol        | Parameter/Test Conditions                        |                                                                                                | Min.                    | Typ. | Max. | Unit          |
|---------------|--------------------------------------------------|------------------------------------------------------------------------------------------------|-------------------------|------|------|---------------|
| $V_{GE(th)}$  | Gate Emitter Threshold Voltage                   | $V_{CE}=V_{GE}, I_C=1\text{mA}$                                                                | 5.0                     | 5.8  | 6.5  | V             |
| $V_{CE(sat)}$ | Collector Emitter Saturation Voltage             | $I_C=25\text{A}, V_{GE}=15\text{V}, T_J=25^\circ\text{C}$                                      |                         | 1.8  | 2.25 |               |
|               |                                                  | $I_C=25\text{A}, V_{GE}=15\text{V}, T_J=125^\circ\text{C}$                                     |                         | 2.1  |      |               |
|               |                                                  | $I_C=25\text{A}, V_{GE}=15\text{V}, T_J=150^\circ\text{C}$                                     |                         | 2.2  |      |               |
| $I_{CES}$     | Collector Leakage Current                        | $V_{CE}=1200\text{V}, V_{GE}=0\text{V}, T_J=25^\circ\text{C}$                                  |                         |      | 100  | $\mu\text{A}$ |
|               |                                                  | $V_{CE}=1200\text{V}, V_{GE}=0\text{V}, T_J=150^\circ\text{C}$                                 |                         |      | 10   | $\text{mA}$   |
| $I_{GES}$     | Gate Leakage Current                             | $V_{CE}=0\text{V}, V_{GE}=\pm 15\text{V}, T_J=25^\circ\text{C}$                                | -400                    |      | 400  | $\text{nA}$   |
| $Q_g$         | Gate Charge                                      | $V_{CE}=600\text{V}, I_C=25\text{A}, V_{GE}=15\text{V}$                                        |                         | 150  |      | $\text{nC}$   |
| $C_{ies}$     | Input Capacitance                                | $V_{CE}=25\text{V}, V_{GE}=0\text{V}, f=1\text{MHz}$                                           |                         | 1.9  |      | $\text{nF}$   |
| $C_{res}$     | Reverse Transfer Capacitance                     |                                                                                                |                         |      | 85   | $\text{pF}$   |
| $t_{d(on)}$   | Turn on Delay Time                               | $V_{CC}=600\text{V}, I_C=25\text{A}$<br>$R_G=30\Omega,$                                        | $T_J=25^\circ\text{C}$  |      | 35   | $\text{ns}$   |
|               |                                                  |                                                                                                | $T_J=125^\circ\text{C}$ |      | 40   | $\text{ns}$   |
|               |                                                  |                                                                                                | $T_J=150^\circ\text{C}$ |      | 45   | $\text{ns}$   |
| $t_r$         | Rise Time                                        | $V_{GE}=\pm 15\text{V},$<br>Inductive Load                                                     | $T_J=25^\circ\text{C}$  |      | 35   | $\text{ns}$   |
|               |                                                  |                                                                                                | $T_J=125^\circ\text{C}$ |      | 40   | $\text{ns}$   |
|               |                                                  |                                                                                                | $T_J=150^\circ\text{C}$ |      | 40   | $\text{ns}$   |
| $t_{d(off)}$  | Turn off Delay Time                              | $V_{CC}=600\text{V}, I_C=25\text{A}$<br>$R_G=30\Omega,$                                        | $T_J=25^\circ\text{C}$  |      | 210  | $\text{ns}$   |
|               |                                                  |                                                                                                | $T_J=125^\circ\text{C}$ |      | 250  | $\text{ns}$   |
|               |                                                  |                                                                                                | $T_J=150^\circ\text{C}$ |      | 270  | $\text{ns}$   |
| $t_f$         | Fall Time                                        | $V_{GE}=\pm 15\text{V},$<br>Inductive Load                                                     | $T_J=25^\circ\text{C}$  |      | 100  | $\text{ns}$   |
|               |                                                  |                                                                                                | $T_J=125^\circ\text{C}$ |      | 150  | $\text{ns}$   |
|               |                                                  |                                                                                                | $T_J=150^\circ\text{C}$ |      | 180  | $\text{ns}$   |
| $E_{on}$      | Turn on Energy                                   | $V_{CC}=600\text{V}, I_C=25\text{A}$<br>$R_G=30\Omega,$                                        | $T_J=125^\circ\text{C}$ |      | 3.4  | $\text{mJ}$   |
|               |                                                  |                                                                                                | $T_J=150^\circ\text{C}$ |      | 3.6  | $\text{mJ}$   |
| $E_{off}$     | Turn off Energy                                  | $V_{GE}=\pm 15\text{V},$<br>Inductive Load                                                     | $T_J=125^\circ\text{C}$ |      | 2.4  | $\text{mJ}$   |
|               |                                                  |                                                                                                | $T_J=150^\circ\text{C}$ |      | 2.55 | $\text{mJ}$   |
| $I_{SC}$      | Short Circuit Current                            | $t_{psc} \leq 10\mu\text{s}, V_{GE}=15\text{V}$<br>$T_J=125^\circ\text{C}, V_{CC}=600\text{V}$ |                         | 100  |      | A             |
| $R_{thJC}$    | Junction to Case Thermal Resistance ( Per IGBT ) |                                                                                                |                         |      | 0.46 | $\text{K/W}$  |

## Anti-Parallel Diode

### ELECTRICAL CHARACTERISTICS ( $T_C=25^\circ\text{C}$ unless otherwise specified)

| Symbol      | Parameter/Test Conditions                         |                                                                                                    | Min. | Typ. | Max. | Unit          |
|-------------|---------------------------------------------------|----------------------------------------------------------------------------------------------------|------|------|------|---------------|
| $V_F$       | Forward Voltage                                   | $I_F=20\text{A}, V_{GE}=0\text{V}, T_J=25^\circ\text{C}$                                           |      | 1.75 | 2.15 | V             |
|             |                                                   | $I_F=20\text{A}, V_{GE}=0\text{V}, T_J=125^\circ\text{C}$                                          |      | 1.6  |      |               |
|             |                                                   | $I_F=20\text{A}, V_{GE}=0\text{V}, T_J=150^\circ\text{C}$                                          |      | 1.55 |      |               |
| $t_{rr}$    | Reverse Recovery Time                             | $I_F=20\text{A}, V_R=600\text{V}$<br>$di_F/dt=-500\text{A}/\mu\text{s}$<br>$T_J=150^\circ\text{C}$ |      | 450  |      | $\text{ns}$   |
| $I_{RRM}$   | Max. Reverse Recovery Current                     |                                                                                                    |      | 21   |      | A             |
| $Q_{RR}$    | Reverse Recovery Charge                           |                                                                                                    |      | 4.6  |      | $\mu\text{C}$ |
| $E_{rec}$   | Reverse Recovery Energy                           |                                                                                                    |      | 1.35 |      | $\text{mJ}$   |
| $R_{thJCD}$ | Junction to Case Thermal Resistance ( Per Diode ) |                                                                                                    |      |      | 1.0  | $\text{K/W}$  |

# MM25G3T120B

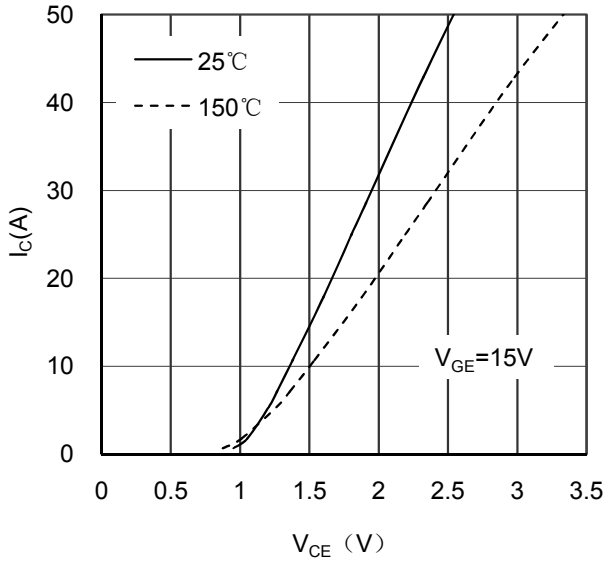

Figure 1. Typical Output Characteristics IGBT

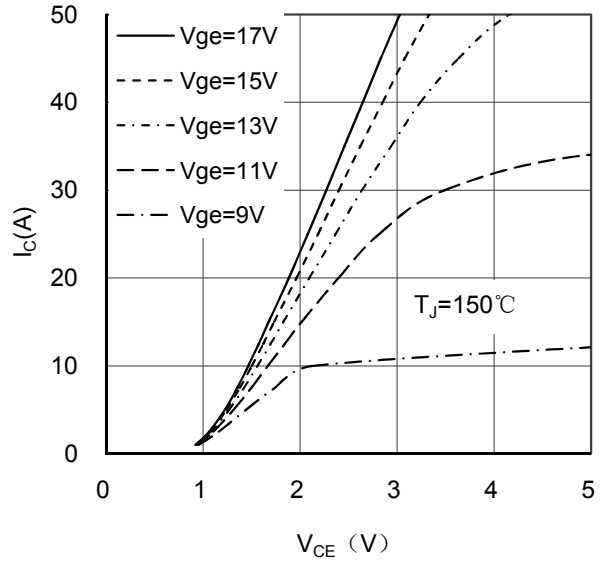

Figure 2. Typical Output Characteristics IGBT

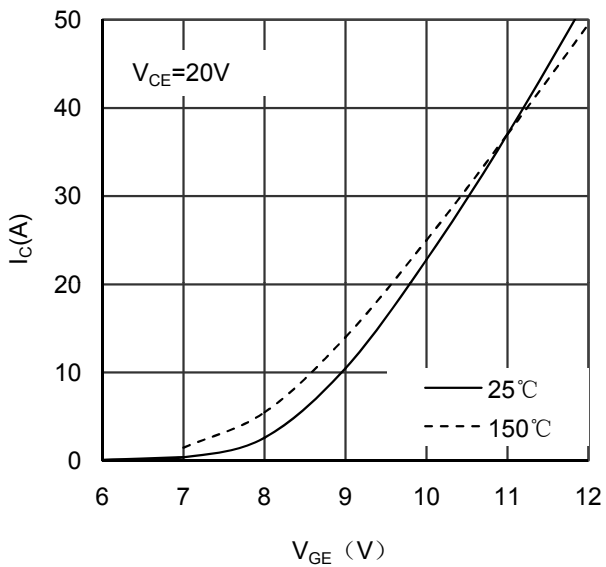

Figure 3. Typical Transfer characteristics IGBT

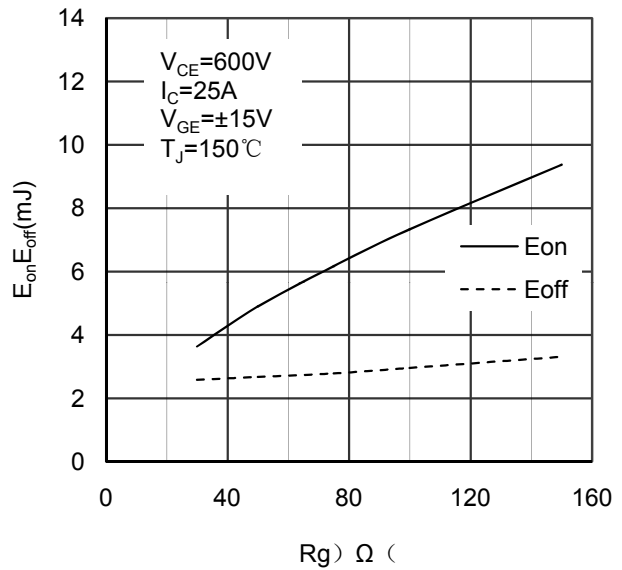

Figure 4. Switching Energy vs Gate Resistor IGBT

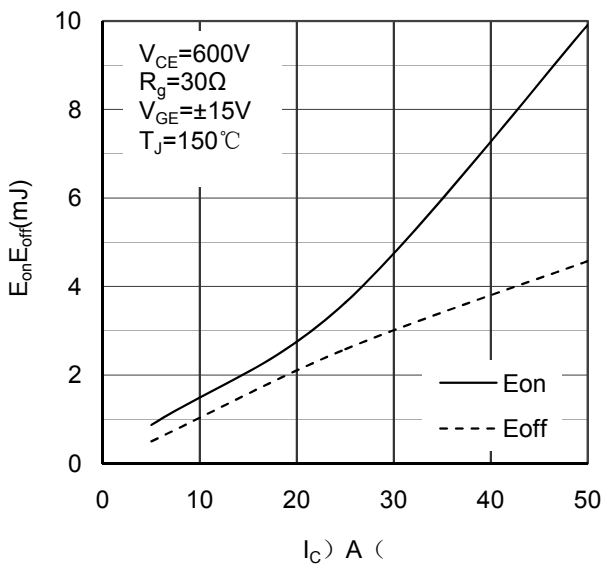

Figure 5. Switching Energy vs Collector Current IGBT

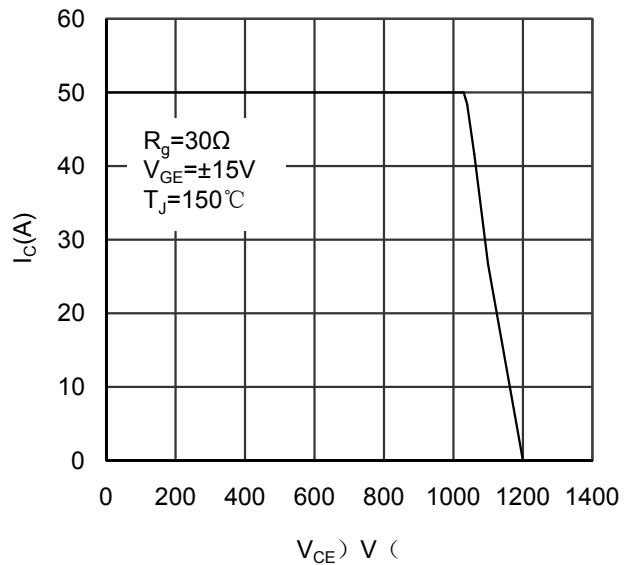

Figure 6. Reverse Biased Safe Operating Area IGBT

# MM25G3T120B

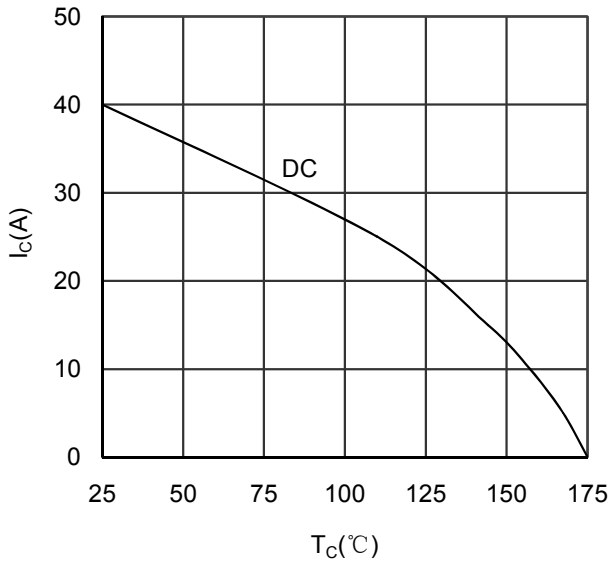

Figure 7. Collector Current vs Case temperature IGBT

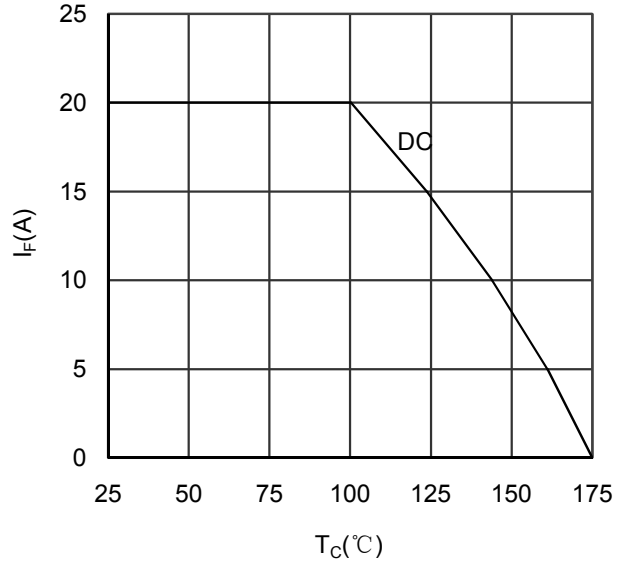

Figure 8. Forward current vs Case temperature Diode

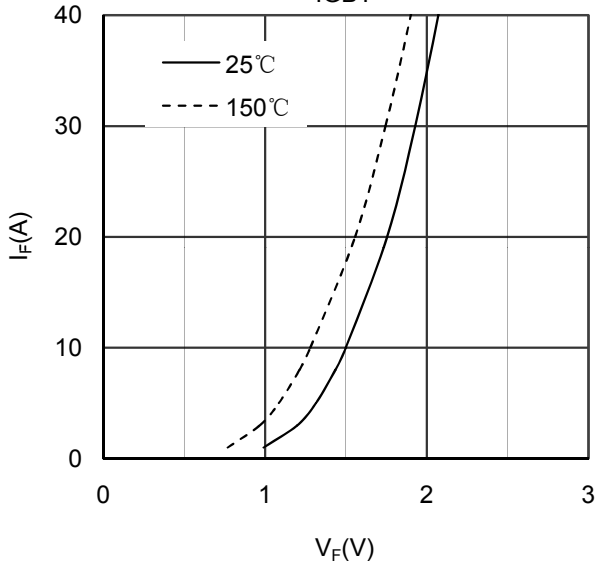

Figure 9. Diode Forward Characteristics Diode

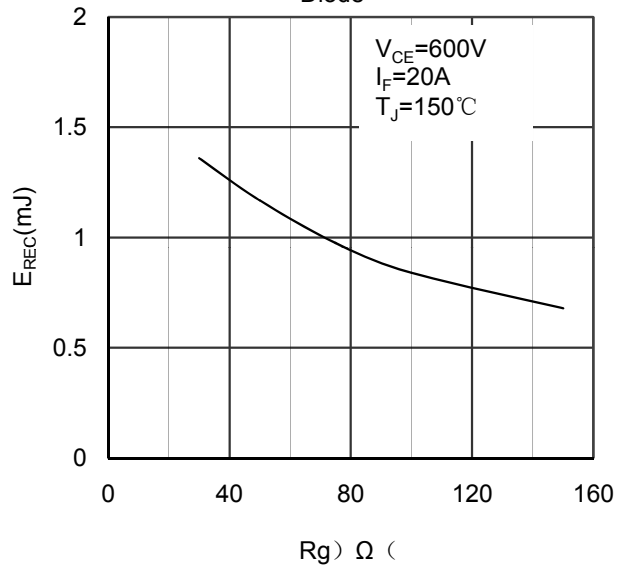

Figure 10. Switching Energy vs Gate Resistor Diode

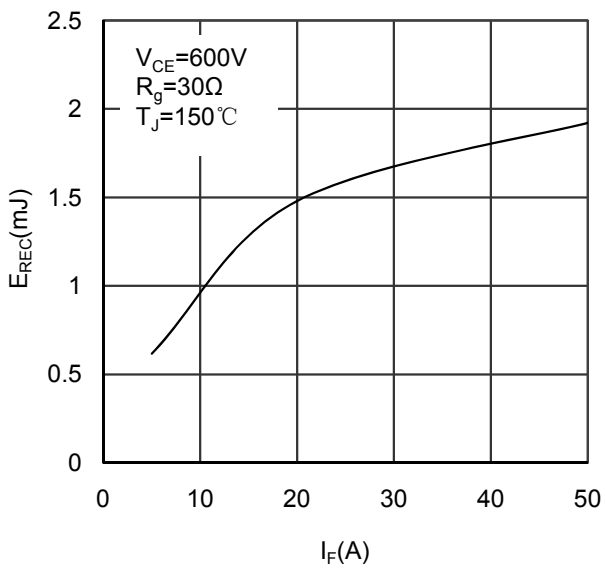

Figure 11. Switching Energy vs Forward Current Diode

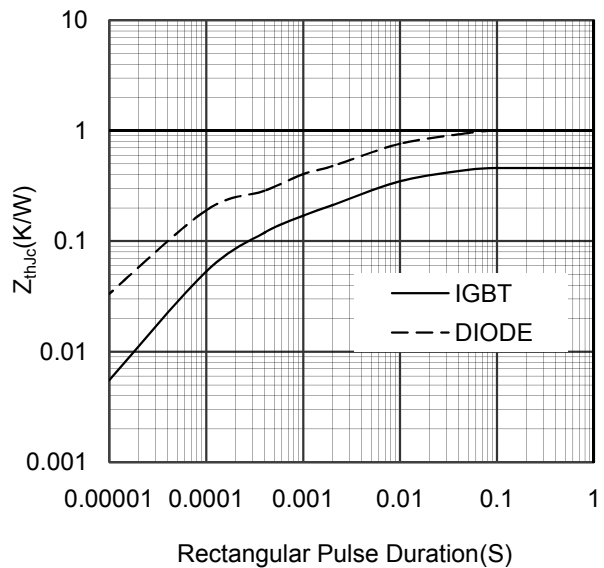
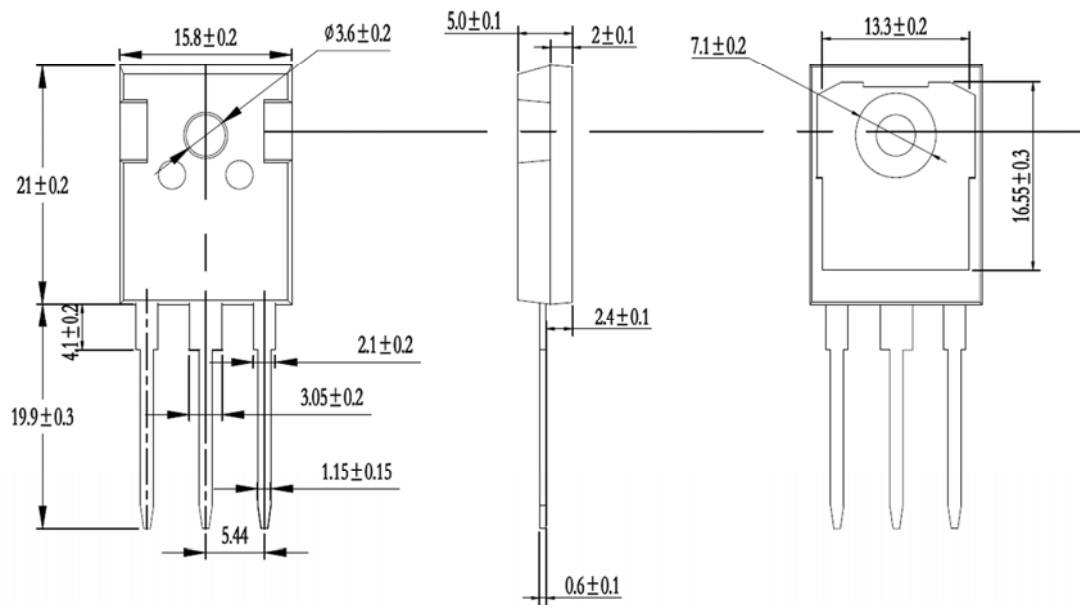

Figure 12. Transient Thermal Impedance of Diode and IGBT



Dimensions in (mm)  
Figure 13. Package Outline